



# Dolux 6" Commercial & Architectural Downlight

QDL6-018-AW/AL

QDL6-025-AW/AL



## Description

Dolux 6" down light features integration design of radiator and outer design, which realize optimal cooling effect and lighting effect. Transparent cover or frosted cover for customer's option. 18W/25W power, Epistar LEDs; 80 CRI and 97 lumen/w lighting effect. Patent design, unique radiator shape design ensure high cooling performance and work in low temperature.

## Features

1. Unique structure ensure optimal cooling effect and lighting effect;
2. Remarkable energy-saving; flexible control system of color difference, to ensure single persistence of light and color;
3. Aluminum alloy shell, ensure product high-end, gorgeous, beautiful design;
4. Power supply and lamp body are designed separately to ensure lifetime of power supply and LEDs better;
5. Metallic luster reflection cup, high lighting effect and uniform light output;
6. Can realize 0-10V dimming or TRIAC dimming.

## Application

Suitable for hotel, corridor passage, home decoration, shopping mall, exhibition room and other places.



## Technical parameters

Model	CCT	Color	Lumen(lm) (±10%)	Beam (angle)	LED Type /Qty.	Power(w) (±10%)	Voltage, Frequency	CRI	PF	Dimming Type
QDL6-018-AW-830K	3000K	Warm White	1540	60°	COB 1pcs	18	AC100-277V 50/60Hz	> 80	≥0.9	0-10V dimming
QDL6-018-AW-840K	4000K	Neutral white	1700							
QDL6-018-AW-850K	5000K	White	1610							
QDL6-025-AW-830K	3000K	Warm White	2005	60°	COB 1pcs	25	AC100-277V 50/60Hz	> 80	≥0.9	0-10V dimming
QDL6-025-AW-840K	4000K	Neutral white	2240							
QDL6-025-AW-850K	5000K	White	2325							
QDL6-018-AL-830K	3000K	Warm White	1540	60°	COB 1pcs	18	AC120V 60Hz	> 80	≥0.9	Triac dimming
QDL6-018-AL-840K	4000K	Neutral white	1700							
QDL6-018-AL-850K	5000K	White	1610							
QDL6-025-AL-830K	3000K	Warm White	2005	60°	COB 1pcs	25	AC120V 60Hz	> 80	≥0.9	Triac dimming
QDL6-025-AL-840K	4000K	Neutral white	2240							
QDL6-025-AL-850K	5000K	White	2325							



## Dimension(Unit:mm)

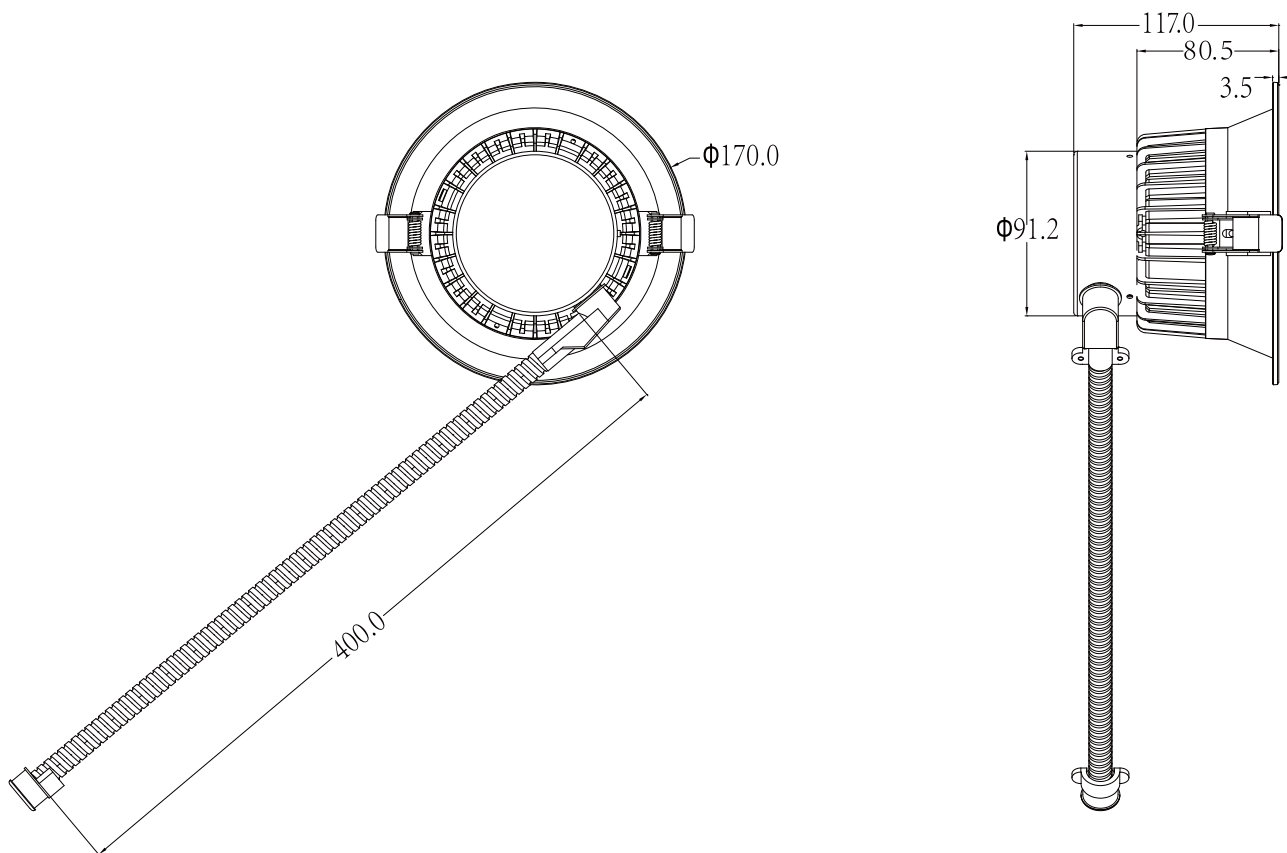

## Test diagram

QDL6-018-AW-830K

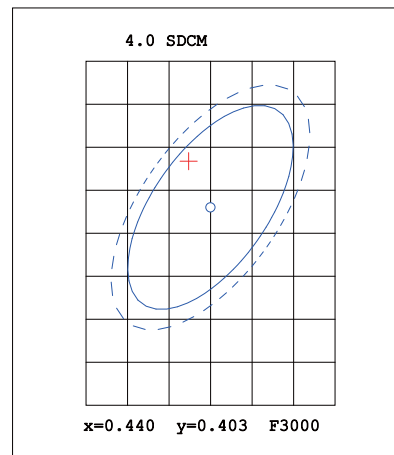
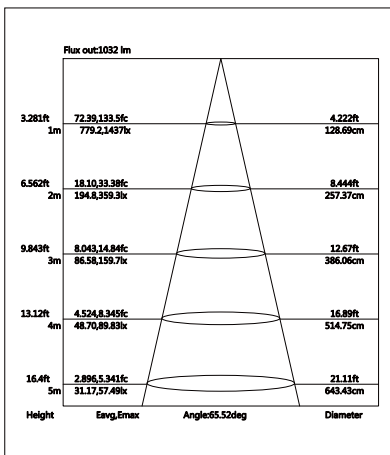
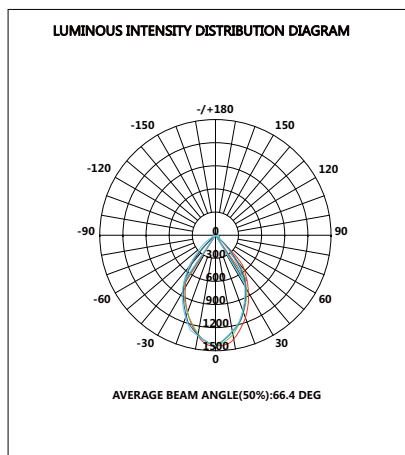



### QDL6-018-AW-840K

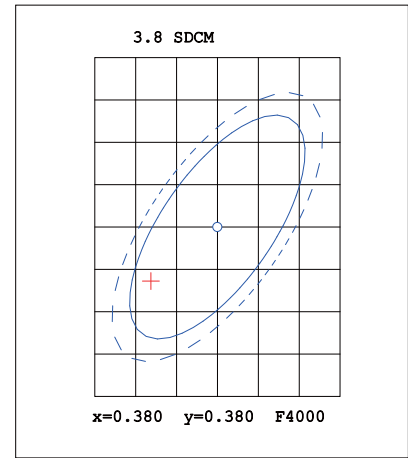
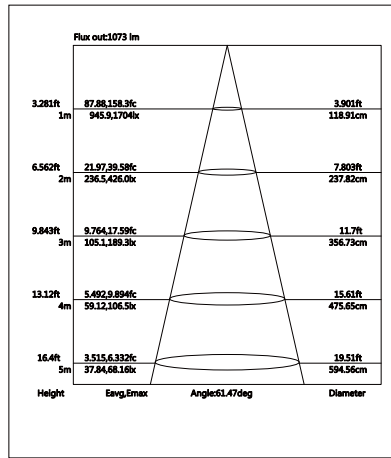
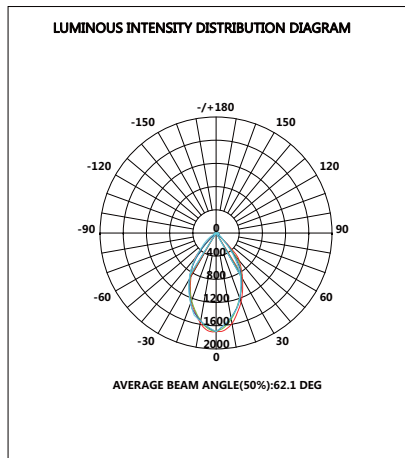

### QDL6-018-AW-850K

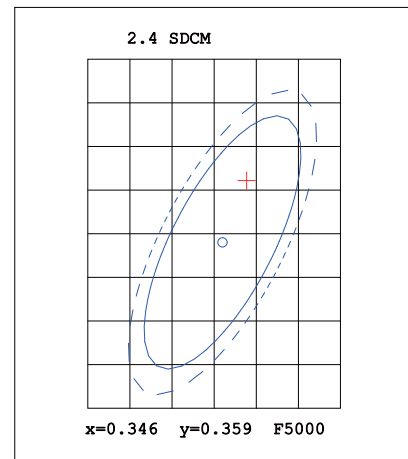
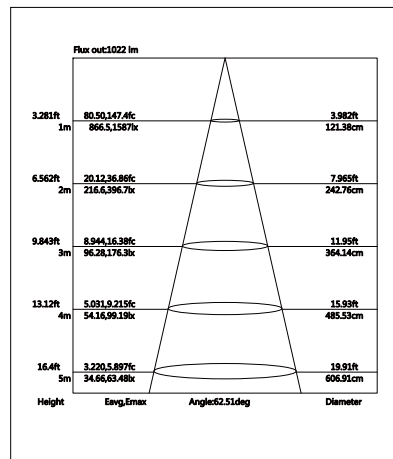
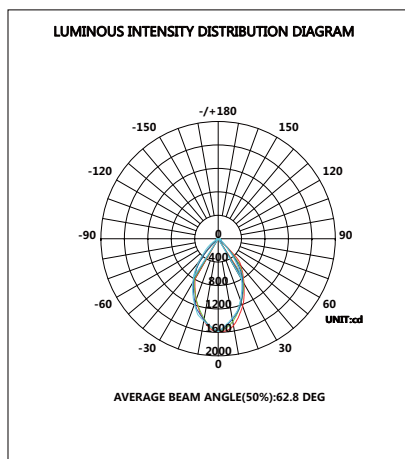

### QDL6-025-AW-830K

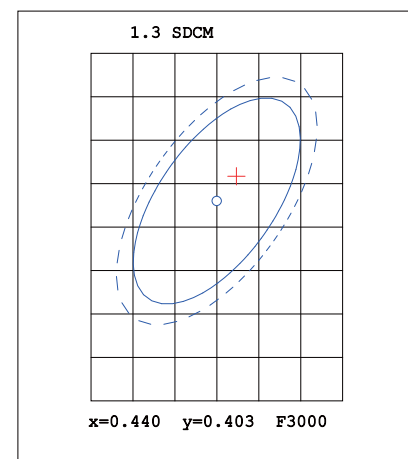
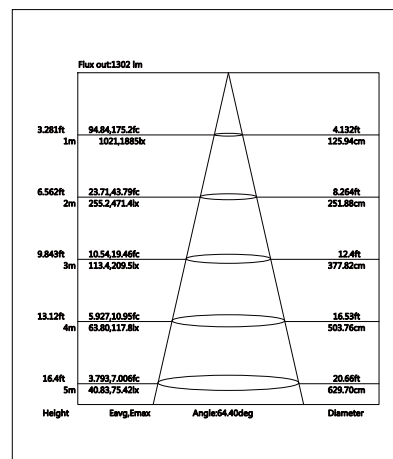
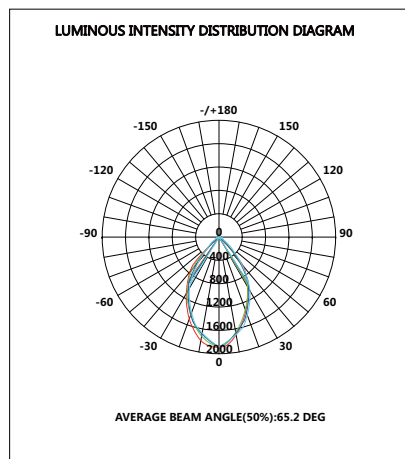



### QDL6-025-AW-840K

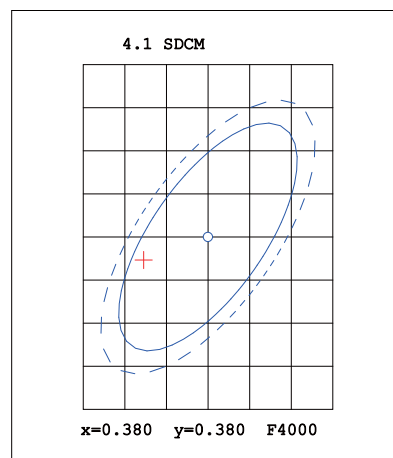
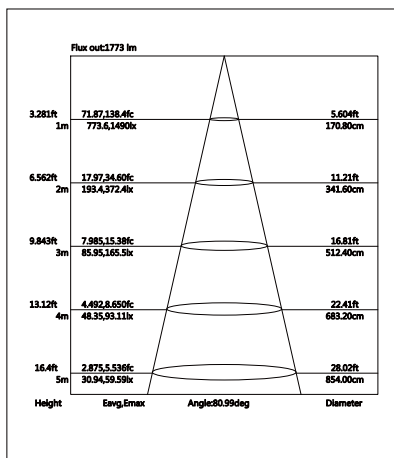
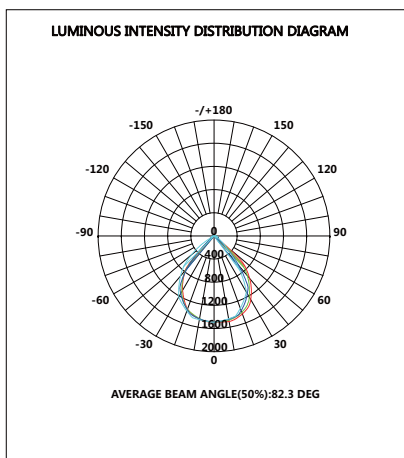

### QDL6-025-AW-850K

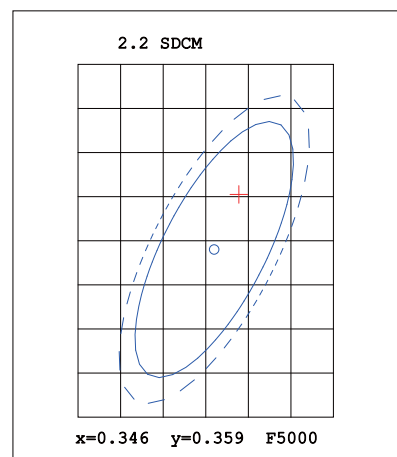
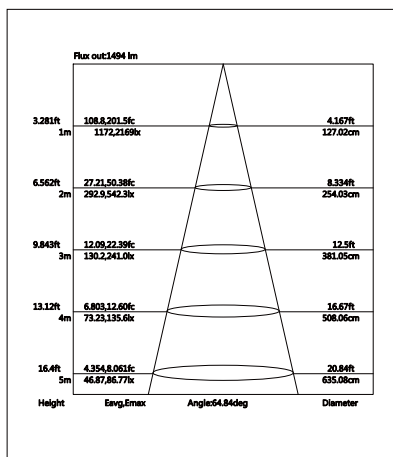
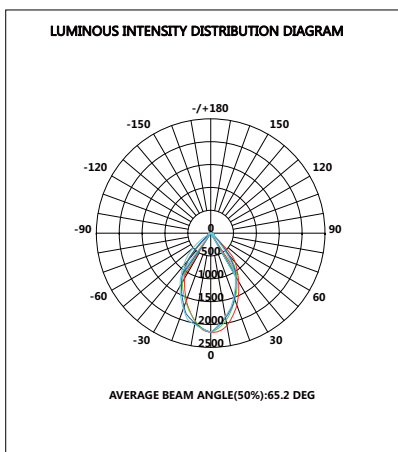

## Packing information

Model	Packing qty.	Inner box dimension	Outer carton dimension	Net weight	Gross weight
6" Dolux Downlight	18PCS	240*190*168mm	590*495*525mm	1.08KG	1.3KG

## Installation

- 1.Power off before installation;
- 2.Connect hose adapter to AC;
- 3.Press spring and snap the lamp into installation hole of ceiling, and clamp the lamp in place;
- 4.Adjust lamp angle to proper position;
- 5.Connect to AC, and lighten the lamp.



## Notice

1. Please read the specification first, to make sure the service environment matches the condition in the specification before using;
2. Please confirm the applicable power supply before using;
3. Make sure the switch of product is off before connect to the power supply to prevent electric shock;
4. Operation against rules may damage your property even harm to your personal safety;
5. Preliminarily estimate required quantity of LED lights, then according to the power rating of single flood light to figure out the total power and design power supply plan;
6. Dangerous high voltage, non-professionals are not allowed to maintain the products;
7. If the exterior flexible cable or wire is damaged, it must be exchanged by the supplier, its agent or other similar qualified personnel to avoid dangers.