

# 0-10V High-voltage Dimming Controller

## LC-000W-AW-02

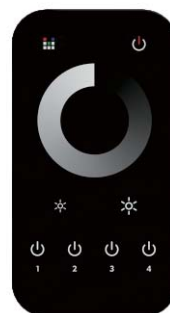

### Description:

High-voltage controller can control single color LED luminaires via 2.4G touch sliding ring remote controller. The controller can control dimming via 2.4G touch sliding ring wireless group remote controller, exquisite dimming, no flicker. One remote controller can control multiple sets of controller.

### Features:

1. Max. control distance up to 40m(in open condition);
2. Smooth surface, comfortable feel;
3. One remote controller can control multiple sets of controller;
4. Realize intelligent full control of whole set of luminaire.

### Technical Parameters:

Working voltage:100-277V(AC)	Remote control distance:40m(in open environment)
Output interface:0-10V(DC),100-277V(AC)	Operating environment: indoor
Output current: 3A	Waterproof level: IP20
Output power: 300W (100V) / 831W (277V)	Operating temperature range:-30 °C -55 °C
Control type: single color luminaire	Packing dimension of controller:L165*W55*H35mm
Radio sending and receiving frequency:2.4GHz	Packing weight of controller(gross weight):about 100g
Receiving sensitivity:-96dBm	Outer carton dimension:L271.5*W224*H173mm
Transmitting power:6dBm	Packing qty. of controller: 30 pieces, about 3.35Kg



## Function description:

### 1. Controller key description

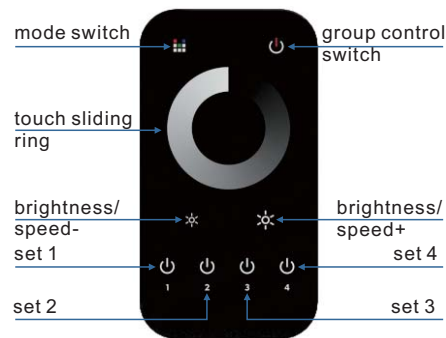

### 2. Matching steps of remote controller



1) After power on controller, short press , press any key on remote controller or sliding ring, then match success.



2) a. Power off controller;



b. Power on controller again;

c. Press any key of matching controller in 5 seconds, matching finish.

### 3. Set control steps of remote controller

(1) Power on the first controller, short press , and touch  on remote controller, then remote controller and the first controller are matched the first set; if you want to add more controllers in the group, just repeat above operation.

(2) Get the second controller, power on, short press , touch  on remote controller, then the remote controller and the second controller are matched the second set; if you want to add more controllers in the set, just repeat above operation. And so on, the third, the fourth set can be matched;

(3) There are 4 groups of controller, if you want to control the first set, only touch , then you can perform dimming operation on the first set; if you want to control the second set, only touch , then you can perform dimming operation on the second set; if you want to control set 1, set 2, set 3, set 4 together, touch , then you can perform dimming operation on all controllers of the 4 sets.

## Dimension (unit:mm):

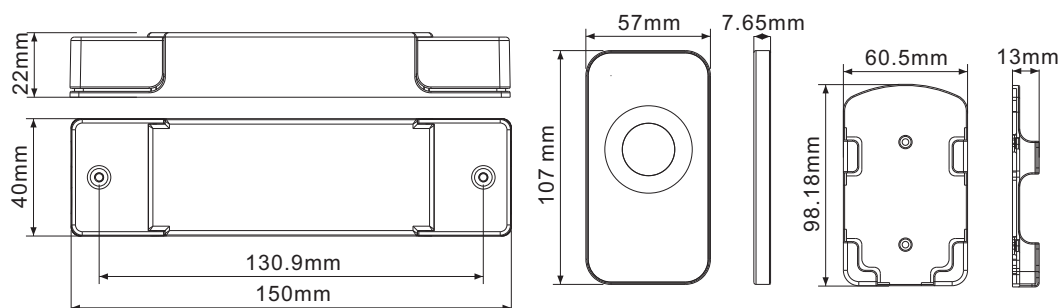



### Wiring diagram:

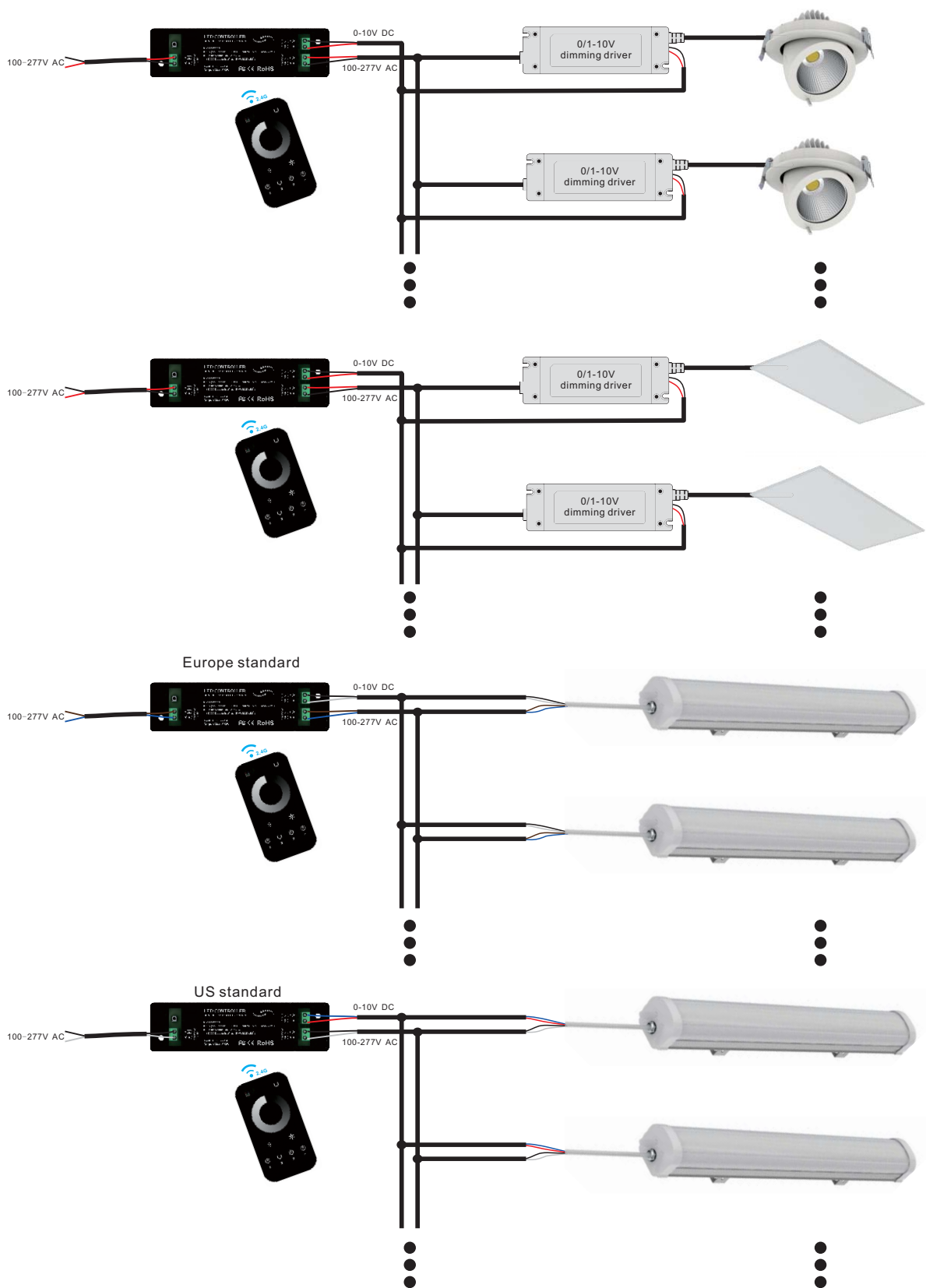



## Set display drawing:

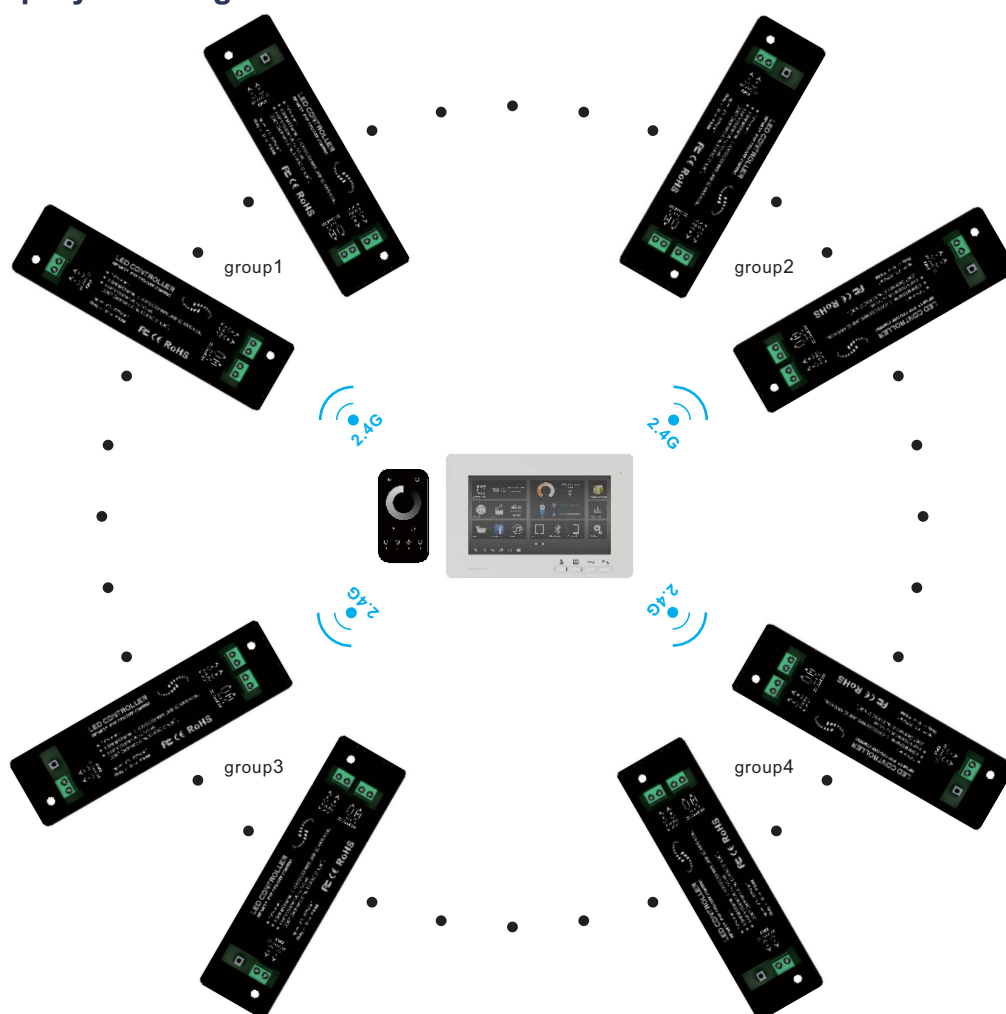

### **!** Notice

1. The controller must be installed by professionals;
2. When installing the controller, first power off, then connect LED products with controller, after doing the right, then power on it;
3. Good cooling conditions will extend lifetime of controller, please install the product in well-ventilated environment;
4. Ensure input voltage conform to voltage range requirement of product;
5. Wire size used must be sufficiently load connected and make sure wires are securely connected;
6. Before power on, ensure that all the wiring is correct to avoid errors caused by wiring lamps damage;
7. If a failure occurs, don't repair without permission, please contact the manufacturer.