

iVAR COB Downlight

DLD06-020

Features:

- * Use die-casting magnesium alloy to make the main body.
- * Use PMMA as the material of panel.
- * Unique and delicate looking design.
- * Excellent heat dissipation performance.
- * The driver and main body use separation design which ensure the long life of both parts.
- * Energy saving LED driver.
- * Can replace traditional downlight.



Dimenions(unit:mm/inch):

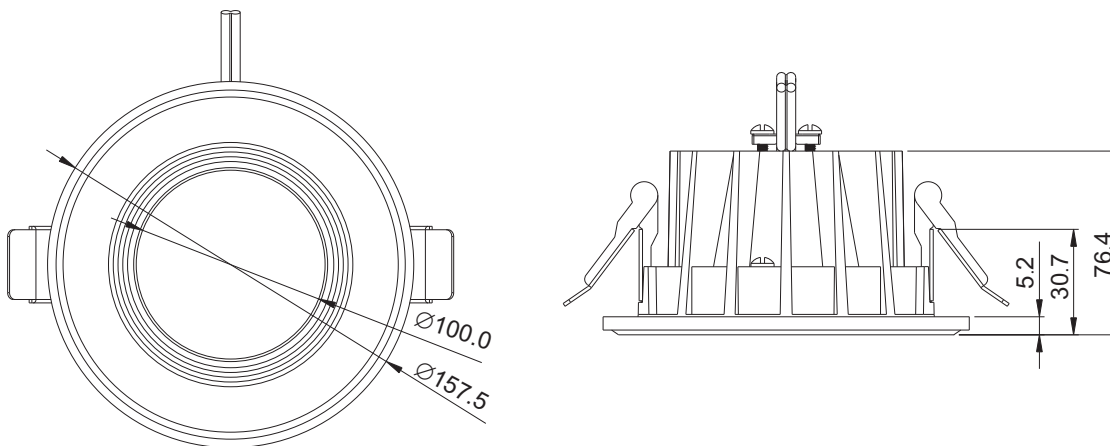

Application:

Widely used in hotel, house, office, parking lot, exhibition, club and other places need indoor lighting.



Specifications:

Model Number	Color	LED Type	Light Output (lumen)	CCT	CRI	Beam Angle (degrees)	Power (W)	Max.Current (mA)	Voltage (VAC)	weight (Kg)	PF
DLD06-020-AW-W-01	White	Epistar COB LED	1530	6000-6300	>80	45°	20W	220	100-240V AC 50/60Hz	0.71	>0.9
DLD06-020-AW-WW-01	Warm White		1300	2900-3100	>80						
DLD06-020-AW-NW-01	Natural White		1590	3900-4100	>80						

Installation drawing:

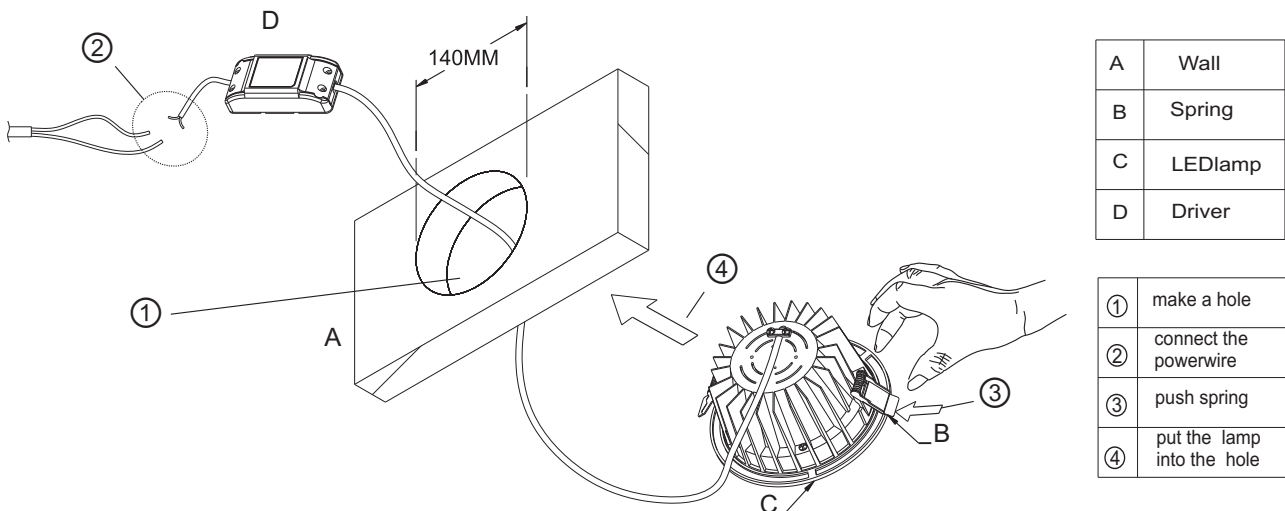

Package Information:

Inner box dimension: 195*185*113MM

Product net weight: 0.61KG Product gross weight: 0.73Kg

Carton box dimension (16PCS inside) : 400*380*470MM

Other cautions:

Power must be cut off before installation, fix it on the position of installation holes, connection of the power supply must be sealed.

1. Please read the specification first, to make sure the service environment matches the condition in the specification before using.
2. Please confirm the applicable power supply before using.
3. Make sure the switch of product is off before connect to the power supply to prevent electric shock.
4. Operation against rules may damage your property even harm to your personal safety.
5. Preliminarily estimate required quantity of LED lights, then according to the power rating of single flood light to figure out the total power and design power supply plan.
6. Dangerous high voltage, Non-professionals are not allowed to maintain the products.

If the exterior flexible cable or wire is damaged, it must exchange by the supplier, its agent or other similar qualified personnels to avoid dangers.