



# JADE 6'' UL surface and recessed mount Downlight



## Description

Jade is a 6" surface and recessed mount downlight, delivering an uniform light beam, no shadow or dark in the middle or around the light. Available 9W, 11W, 15W, 100lm/W@3000K for 9W, 11W. 96lm/W@3000K for 15W. Jade can fit 4" and 5" junction boxes as well as 5" & 6" downlight housings.

Operating Temperature: -20~45° C, Storage Temperature: -20~70° C.

## Features

1. Adopt aluminum alloy as material, stamping process;
2. Unique appearance, beautiful design and gorgeous;
3. Excellent thermal management to ensure long lifetime of LED;
4. surface and recessed mount , delivering an uniform light beam, no shadow or dark in the middle or around the light;
5. High efficiency and energy-saving LED driver;
6. Triac dimmable.

## Application

Suitable for hotel, corridor, home decoration, shopping mall, exhibition room, etc.



## Technical parameters

Model	CCT	Color	Lumen(lm) (±10%)	Beam (angle)	LED Type /Qty.	Power(w) (±10%)	Voltage, Frequency	CRI	PF	Dimming Type
SDR6-009-AL-850K	5000K	White	968	100°	2835 48pcs	9	AC120V 60Hz	> 80	≥0.9	Triac dimming
SDR6-009-AL-840K	4000K	Neutral white	897							
SDR6-009-AL-835K	3500k	Warm white	934							
SDR6-009-AL-830K	3000K	Warm white	930							
SDR6-009-AL-827K	2700K	Warm white	874							
SDR6-011-AL-850K	5000K	white	1202	100°	2835 48pcs	11	AC120V 60Hz	> 80	≥0.9	Triac dimming
SDR6-011-AL-840K	4000K	Neutral white	1057							
SDR6-011-AL-835K	3500K	Warm white	1144							
SDR6-011-AL-830K	3000k	Warm white	1118							
SDR6-011-AL-827K	2700K	Warm white	1053							
SDR6-015-AL-850K	5000K	white	1583	100°	2835 48pcs	15	AC120V 60Hz	> 80	≥0.9	Triac dimming
SDR6-015-AL-840K	4000K	Neutral white	1489							
SDR6-015-AL-835K	3500k	Warm white	1508							
SDR6-015-AL-830K	3000K	Warm white	1421							
SDR6-015-AL-827K	2700K	Warm white	1422							



## Dimension(Unit:mm)

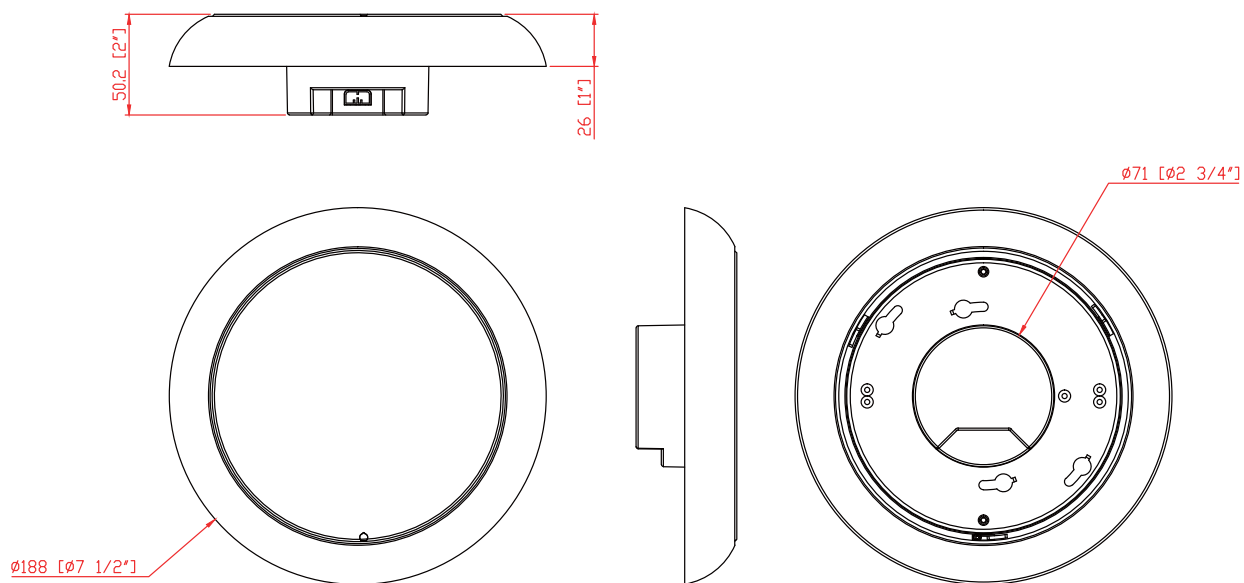

## Accessories

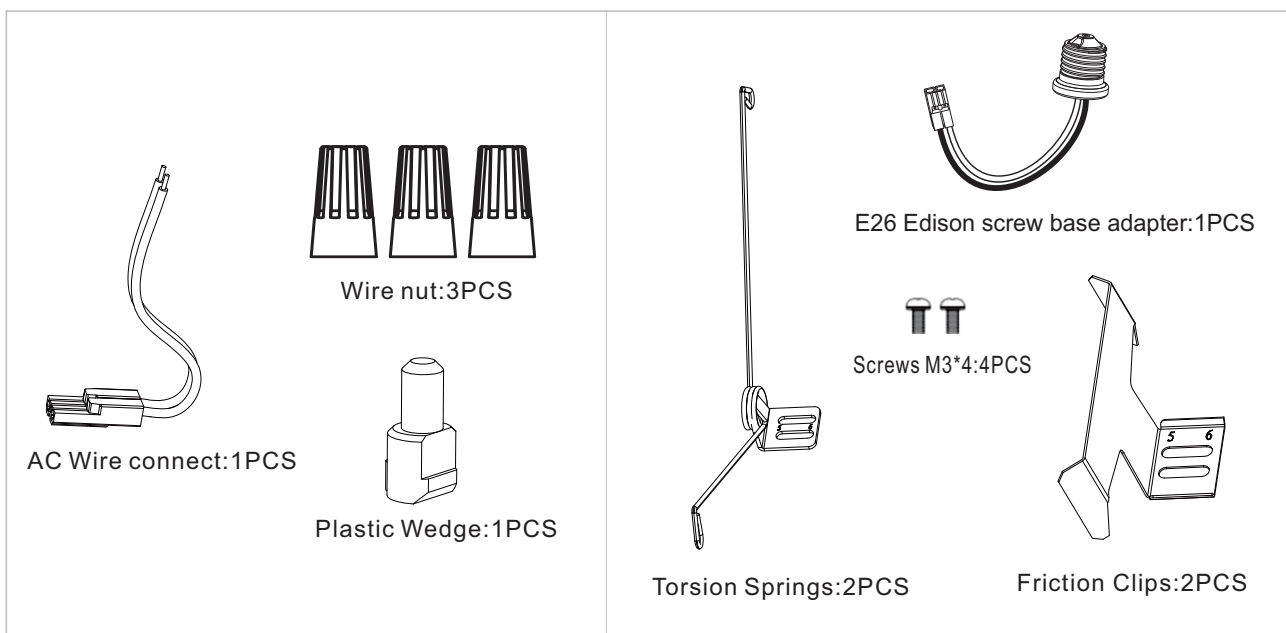

Surface Mount

Recessed Mount



## Test diagram

### SDR6-009-AL-827K

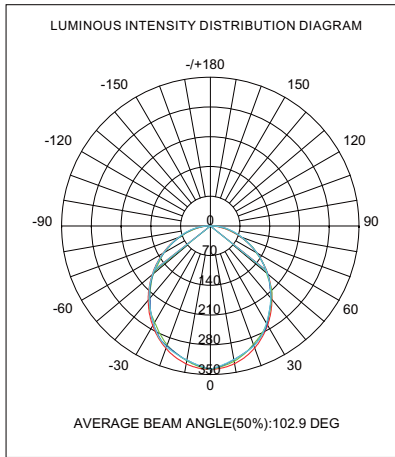

### SDR6-011-AL-827K

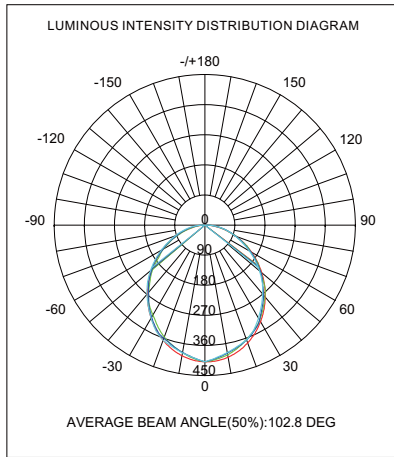

### SDR6-015-AL-827K

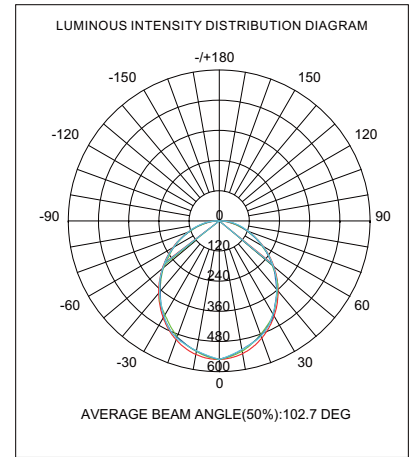

### SDR6-009-AL-830K

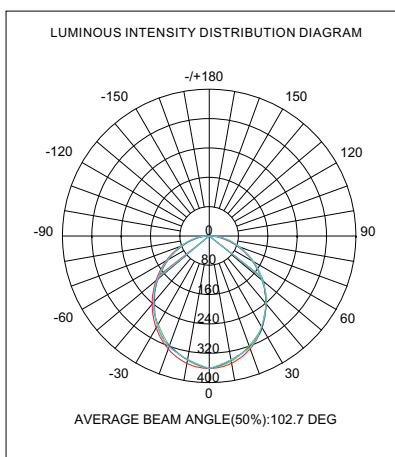

### SDR6-011-AL-830K

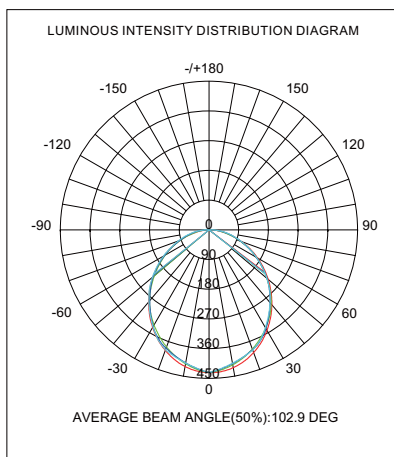

### SDR6-015-AL-830K

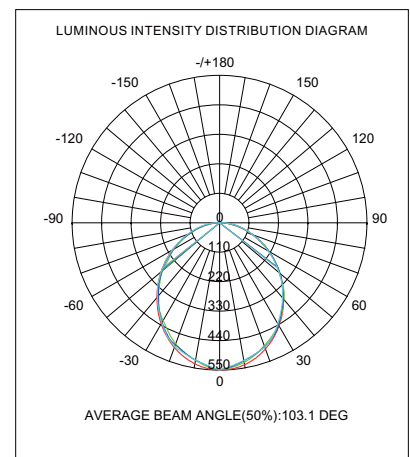

### SDR6-009-AL-835K

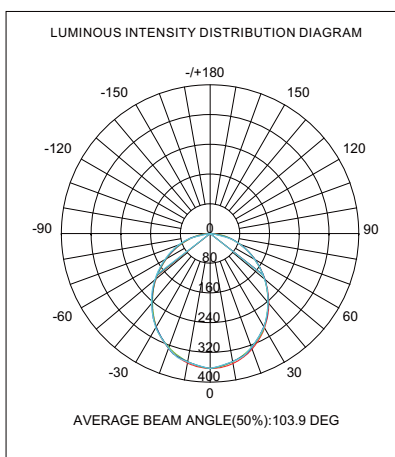

### SDR6-011-AL-835K

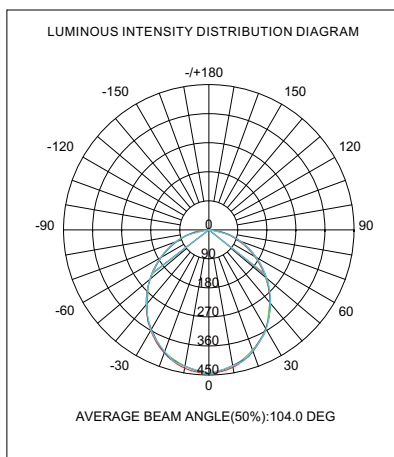

### SDR6-015-AL-835K

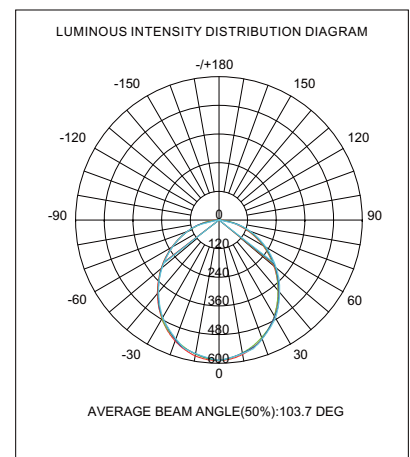



SDR6-009-AL-840K

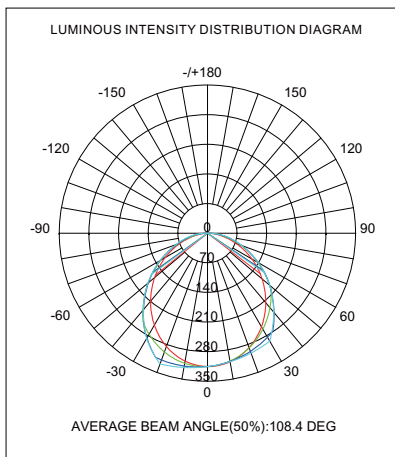

SDR6-011-AL-840K

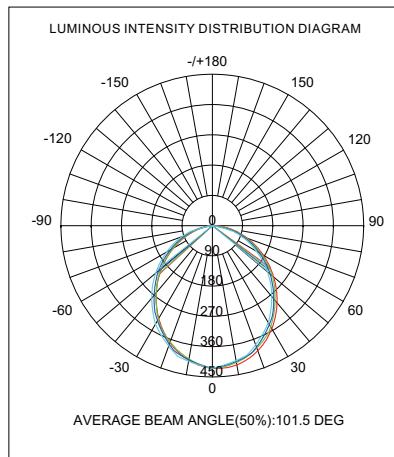

SDR6-015-AL-840K

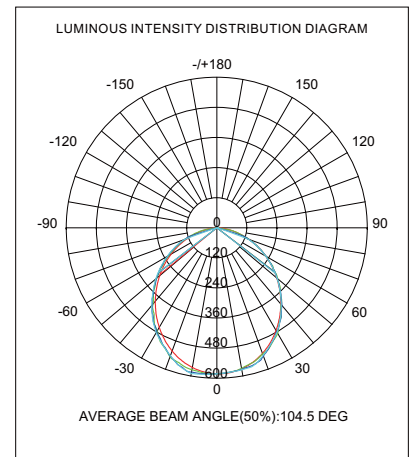

SDR6-009-AL-850K

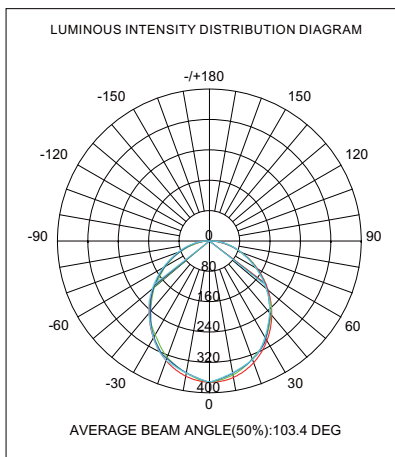

SDR6-011-AL-850K

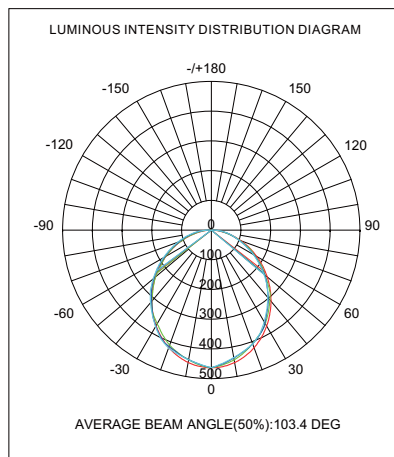

SDR6-015-AL-850K

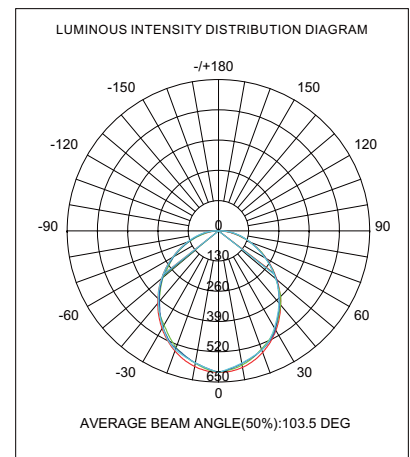

## Packing information

Model	Packing qty.	Inner box dimension	Outer carton dimension	Net weight	Gross weight
6" UL Downlight	16PCS	200*200*80mm	420*350*430mm	5. 2KG	8.5KG

## ! Notice

1. Please read the specification first, to make sure the service environment matches the condition in the specification before using.
2. Please confirm the applicable power supply before using.
3. Make sure the switch of product is off before connect to the power supply to prevent electric shock.
4. Operation against rules may damage your property even harm to your personal safety.
5. Preliminarily estimate required quantity of LED lights, then according to the power rating of single flood light to figure out the total power and design power supply plan.
6. Dangerous high voltage, Non-professionals are not allowed to maintain the products.
7. If the exterior flexible cable or wire is damaged, it must exchange by the supplier, its agent or other similar qualified personnels to avoid dangers.