



HL1935 Linear Light

SC-HL1935-006-24V-02W

SC-HL1935-006-24V-02NW

SC-HL1935-006-24V-02WW

Description

LED linear light is exclusively designed for designer and architect with imagination and personal style. LED linear light adopt premium aluminum profile, different dimension and size, easy to install. 3 types installation method: ceiling mounted type, suspended type and embedded type, and different customized dimensions are also acceptable, which can meet installation requirement of different fields and occasions.

Features

1. Color: cool white(5000-6500K), natural white(3700-4500K) warm white(2700-3200K), other available.
2. Beam angle: 110 Degree
3. Saving energy: 50%
4. Life span more than 50,000Hrs
5. IP code: IP40
6. Standard warranty: 3years
7. Follow CE Certified.



Technical Parameter

Input Voltage: DC 24V
LED type: 2835 SMD LED
Input Power: 6W
Reflector: Milky cover

Applications

- Hotels
- Conference/Meeting rooms
- Factories and offices
- Commercial purposes
- Residential / Institution buildings
- Schools, colleges, universities and hospitals
- Places which needs energy saving and high color rendering index lighting.

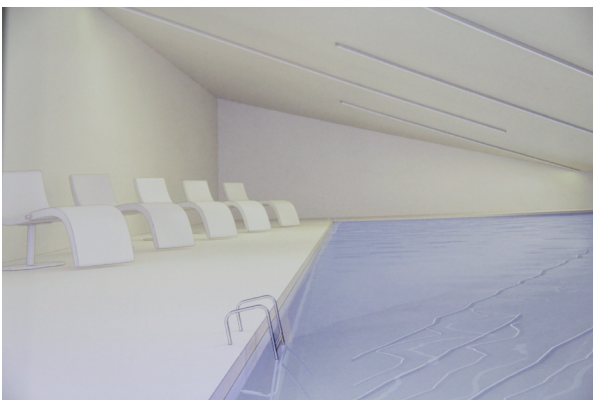



Specifications

Model #	CCT	LED Type	Lumen(lm) (±10%)	CRI	Beam angle	Power(W) (±10%)	Voltage (V)	PF	Weight (Kg)
SC-HL1935-006-24V-02W	5000-6500K	2835	522lm	>80	110°	6W	DC 24V	/	0.18
SC-HL1935-006-24V-02NW	3700-4500K		506lm	>80	110°	6W			
SC-HL1935-006-24V-02WW	2700-3200K		466lm	>80	110°	6W			

Product packaging information:

1. Net weight: 0.18 kg
2. Gross weight/Carton: 9.6 kg
3. Packing size: 690X400X265mm
4. 1 pcs per inner box, 50 inner boxes per carton.

All dimension units are millimeter.

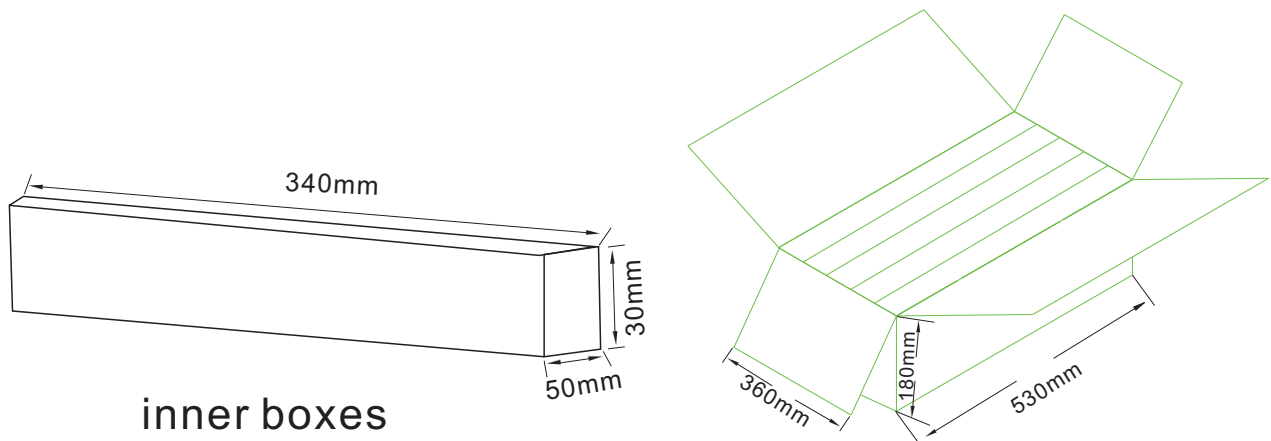

Dimensions (Unit: mm/inch)

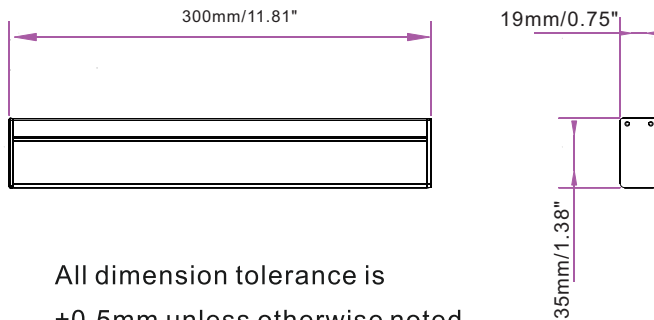

All dimension tolerance is
±0.5mm unless otherwise noted.



Electrical Connection

DC 24V

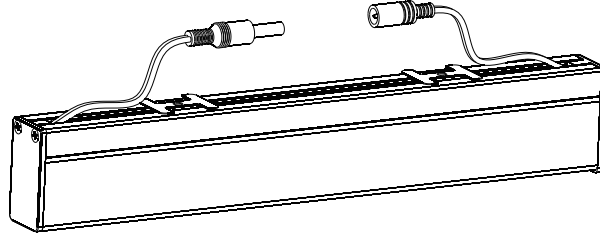

How to fix

Embedded Installation Diagram

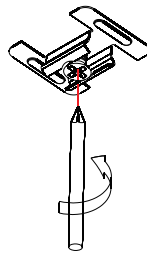

1. Fix the embeded spring on the lamp according the panel thickness.

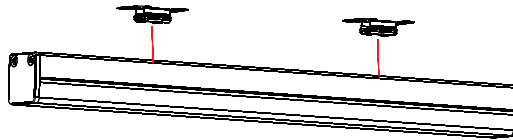

2. Connect power wire, and align the opening hole, finally snap the lamp into installing opening fasten the spings, finish installation.

! Notice

1. Please read the specification first, to make sure the service environment matches the condition in the specification before using.
2. Please confirm the applicable power supply before using.
3. Make sure the switch of product is off before connect to the power supply to prevent electric shock.
4. Operation against rules may damage your property even harm to your personal safety.
5. Preliminarily estimate required quantity of LED linear lights, then according to the power rating of single linear light to figure out the total power and design power supply plan.
6. Dangerous high voltage, Non-professionals are not allowed to maintain the products.
7. If the exterior flexible cable or wire is damaged, it must exchange by the supplier, its agent or other similar qualified personnels to avoid dangers.