



# RL4932 LED Linear Light

SC-RL4932-018-AW-01W

SC-RL4932-018-AW-01NW

SC-RL4932-018-AW-01WW

## Description

LED linear light is exclusively designed for designer and architect with imagination and personal style. LED linear light adopt premium aluminum profile, different dimension and size, easy to install. 3 types installation method: ceiling mounted type, suspended type and embedded type, and different customized dimensions are also acceptable, which can meet installation requirement of different fields and occasions.

## Features

1. Color: cool white(5000-6500K), natural white(3700-4500K) warm white(2700-3200K), other available.
2. Power factor > 0.95
3. Beam angle: 110 Degree
4. Saving energy: 50%
5. Life span more than 50,000Hrs
6. IP code: IP40
7. Standard warranty: 3years
8. Follow CE Certified.



## Technical Parameter

Input Voltage: AC 100-240V 50/60Hz

LED type: 2835 SMD LED

Input Power: 18W

Reflector: Milky cover

## Applications

- Hotels
- Conference/Meeting rooms
- Factories and offices
- Commercial purposes
- Residential / Institution buildings
- Schools, colleges, universities and hospitals
- Places which needs energy saving and high color rendering index lighting.





## Specifications

Model #	CCT	LED Type	Lumen(lm) (±10%)	CRI	Beam angle	Power(W) (±10%)	Voltage (V)	PF	Weight (Kg)
SC-RL4932-018-AW-01W	5000-6500K	2835	1375lm	>80	110°	18W	AC 100-240V 50/60Hz	>0.95	0.75
SC-RL4932-018-AW-01NW	3700-4500K		1412lm	>80	110°	18W			
SC-RL4932-018-AW-01WW	2700-3200K		1197lm	>80	110°	18W			

## Product packaging information:

1. Net weight: 0.75 kg
2. Gross weight/Carton: 12.06 kg
3. Packing size: 740X425X206mm
4. 1 pcs per inner box, 15 inner boxes per carton.

All dimension units are millimeter.

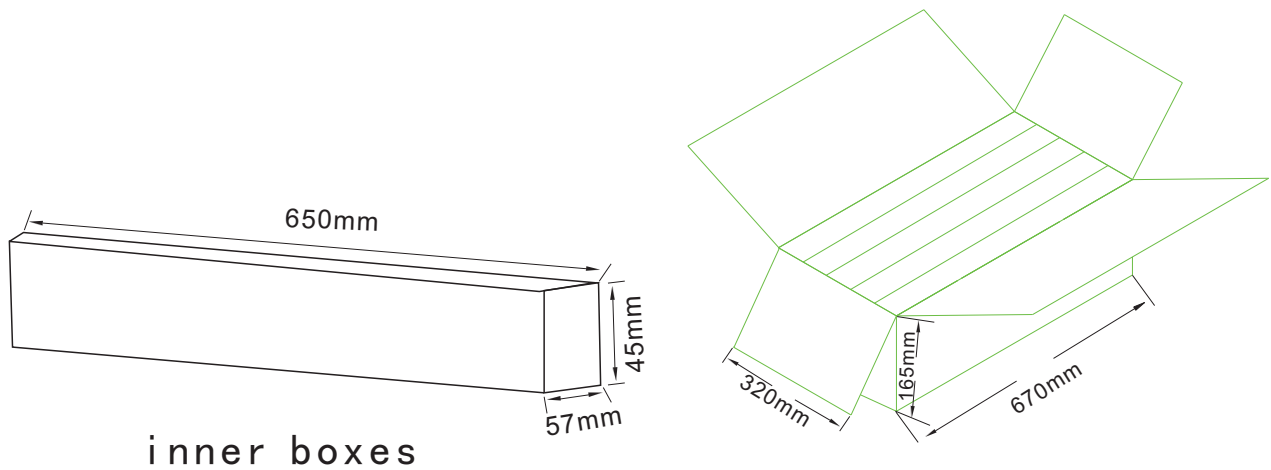

## Dimensions (Unit: mm/inch)

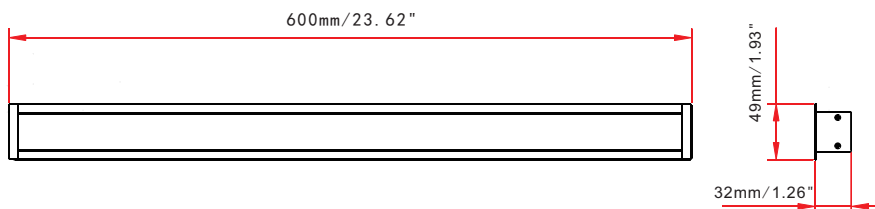

All dimension tolerance is  
±0.5mm unless otherwise noted.



## Electrical Connection

### Linear Light

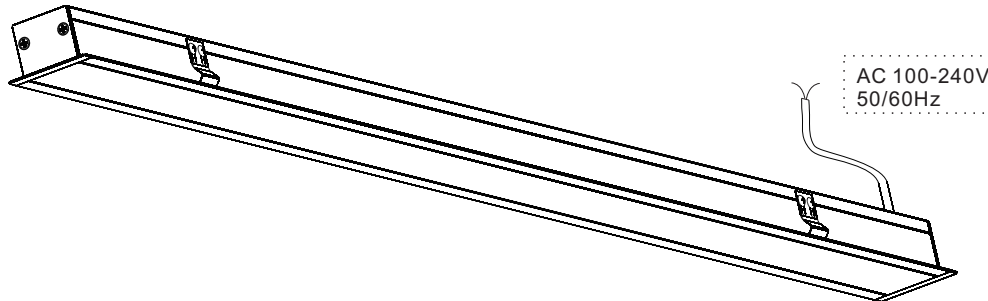

## How to fix

### Suspending Installation Diagram

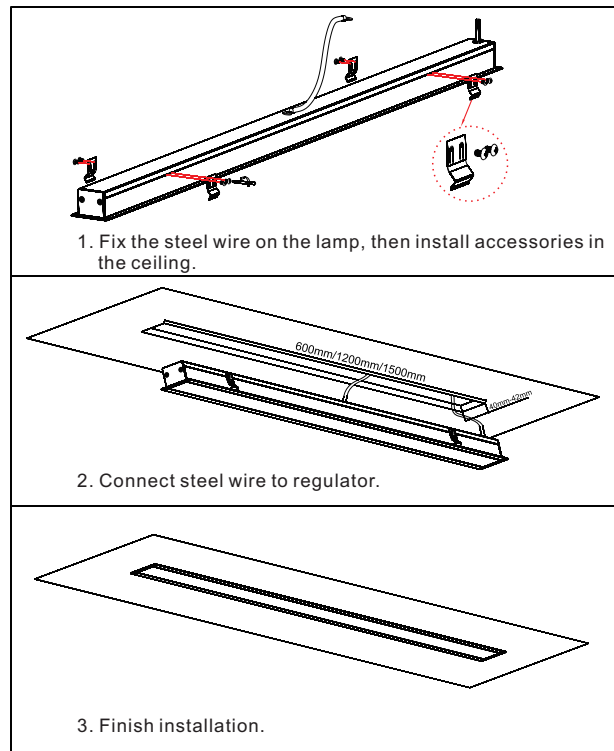

## ! Notice

1. Please read the specification first, to make sure the service environment matches the condition in the specification before using.
2. Please confirm the applicable power supply before using.
3. Make sure the switch of product is off before connect to the power supply to prevent electric shock.
4. Operation against rules may damage your property even harm to your personal safety.
5. Preliminarily estimate required quantity of LED linear lights, then according to the power rating of single linear light to figure out the total power and design power supply plan.
6. Dangerous high voltage, Non-professionals are not allowed to maintain the products.
7. If the exterior flexible cable or wire is damaged, it must exchange by the supplier, its agent or other similar qualified personnels to avoid dangers.