



6" LED Panel Light

DL-011-AW-02W-F
DL-011-AW-02NW-F
DL-011-AW-02WW-F

Description

LED Round Panel Light can perfectly replace traditional downlight. Using Light Guide Plate, it has the feature of uniform and smooth light beam, low glare rating, low light pollution, and excellent protection from eyestrain. It can be widely used as interior lighting in shops, supermarkets, malls and hospitals, etc

Features

1. Color: cool white(5000-6500K), nature white(3700-4500K)
warm white(2700-3200K), other available.
2. Power factor > 0.95
3. UGR < 19
4. Beam angle: 110 Degree
5. Saving energy: 50%
6. Life span more than 36,000Hrs
7. IP code: Ip43
8. Standard warranty: 3years
9. Follow CE Certified.

Technical Parameter

Input Voltage: AC100-277V 50/60Hz
Max Current: 0.26A
LED type: 2835 SMD LED
Output Power: 11W
Reflector: Opal color PMMA



Applications

- Hotels
- Conference/Meeting rooms
- Factories and offices
- Commercial purposes
- Residential / Institution buildings
- Schools, colleges, universities and hospitals
- Places which needs energy saving and high color rendering index lighting.





Specifications

Model #	CCT	LED Type	Lumen(lm) (±10%)	CRI	Beam angle	Power(W) (±10%)	Voltage (V)	PF	Weight (Kg)
DL-011-AW-02W-F	5000-6500K	2835	871lm	>80	110°	11W	AC100-277V 50/60Hz	>0.95	0.47
DL-011-AW-02NW-F	3700-4500K		885lm	>80	110°	11W			
DL-011-AW-02WW-F	2700-3200K		841lm	>80	110°	11W			

Product packaging information:

1. Net weight: 0.47kg
2. Gross weight/Carton: 13.4kg
3. Packing size: 900X290X250mm (20pcs per box)

All dimension units are millimeter.

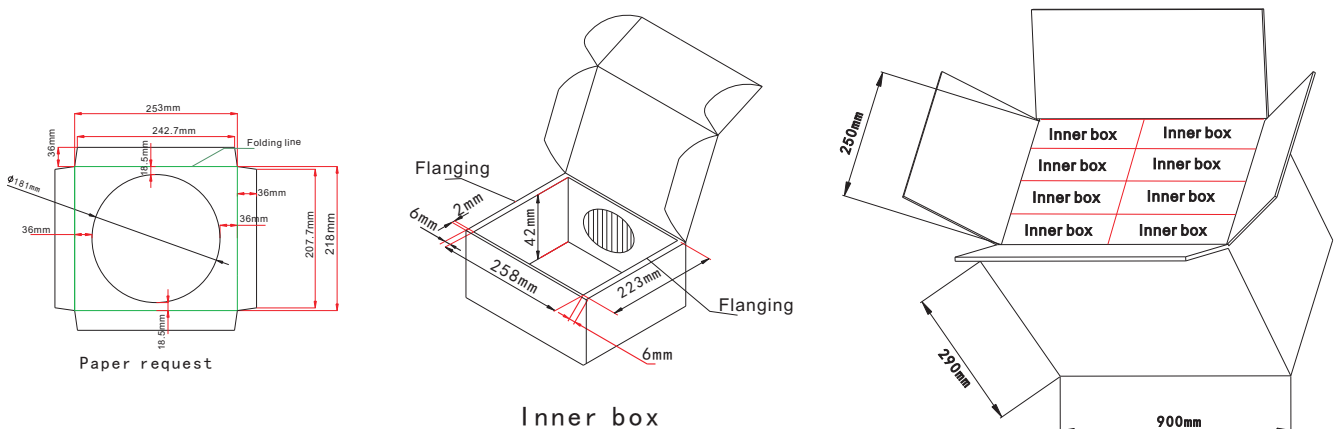

Dimensions (Unit: mm/inch)

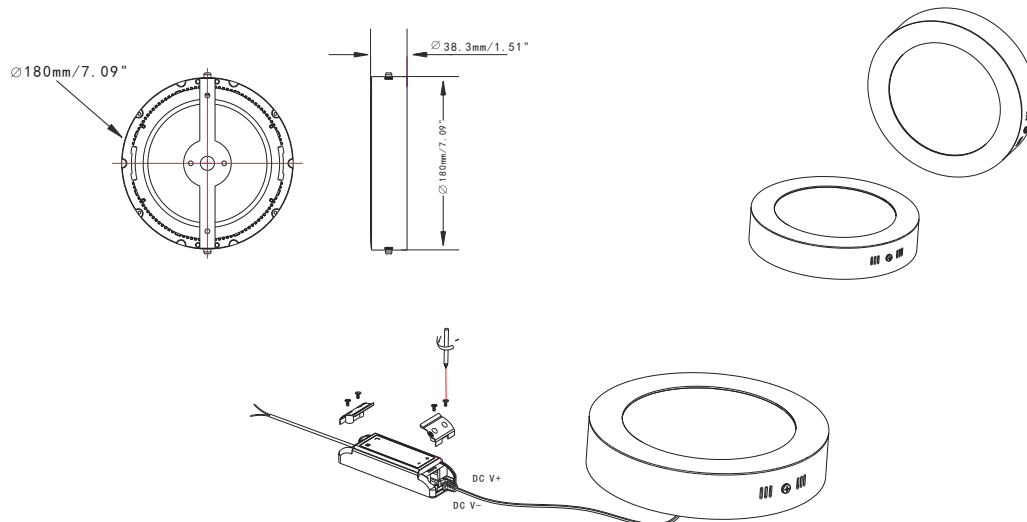



How to fix

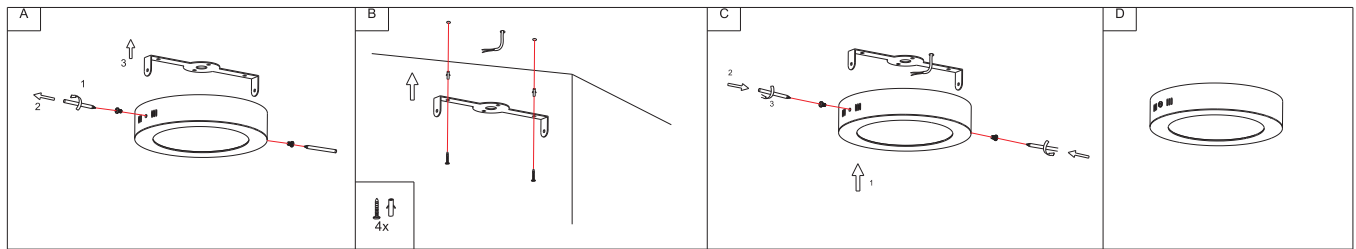

1. The suction head frame mounted to the ceiling

2. Pull the power cord through the upper frame and small box.

3. The lamps and lanterns is installed upwards into the suction within the upper frame, on the number of the accessories, mounted the top screw.

4. The installation in complete.

! Notice

1. Please read the specification first, to make sure the service environment matches the condition in the specification before using.
2. Please confirm the applicable power supply before using.
3. Make sure the switch of product is off before connect to the power supply to prevent electric shock.
4. Operation against rules may damage your property even harm to your personal safety.
5. Preliminarily estimate required quantity of LED panel lights, then according to the power rating of single panel light to figure out the total power and design power supply plan.
6. Dangerous high voltage, Non-professionals are not allowed to maintain the products.
7. If the exterior flexible cable or wire is damaged, it must exchange by the supplier, its agent or other similar qualified personnels to avoid dangers.