



VERO TRACK LIGHT

TL-010-AW



Description

VERO TRACK LIGHT ,as its name ,is installed on track . As its adjustable beam angle ,it is mainly applied in commercial places needing accent lighting, such as shopping mall (clothing store,furniture store and other brand shops), car showroom, jewelry, stars hotel, brand clothing, upscale club, culture relics exhibition hall, chain store, brand business hall, professional cabinet, counter and other accent lighting places.

Features

- 1.Movable track, convenient to adjust its places for different lighting purposes ;
- 2.Energy saving, no UV or IR, no mercury, RoHS compliant;
- 3.Aluminum profile+glass diffusion plate, soft light without dazzling;
- 4.High transmittance, uniform luminous surface, no dark spot, non grainy;
- 5.High efficient heat dissipation,high efficient heat dissipation;
- 6.Can on-off frequently, no flicker and flare ,good color rendering performance.



Main Applications

Mainly applied in commercial places, such as shopping mall (clothing store, furniture store and other brand shops), car showroom, jewelry, stars hotel, brand clothing, upscale club, culture relics exhibition hall, chain store, brand business hall, professional cabinet, counter and other accent lighting places.



Specifications

Model #	CCT	Lumen (lm) (±10%)	Beam angle	Recommended Track	Power(w) (±10%)	LED type and Qty	Voltage, Frequency, current	CRI	PF	Lifespan
TL-010-AW-W-01	5000-6500K	790	18°	2-wire track	10	Cree CXA1507 1pcs	100-240Vac 50/60Hz <0.15A	≥80	≥0.9	45000H
TL-010-AW-NW-01	4000-4500K	740								
TL-010-AW-WW-01	2700-3200K	730								
TL-010-AW-W-02	5000-6500K	730	24°							
TL-010-AW-NW-02	4000-4500K	730								
TL-010-AW-WW-02	2700-3200K	700								
TL-010-AW-W-03	5000-6500K	730	36°							
TL-010-AW-NW-03	4000-4500K	730								
TL-010-AW-WW-03	2700-3200K	670								
TL-010-AW-WW-04	2700-3200K	670	18°	3-wire track						
TL-010-AW-NW-04	4000-4500K	730								
TL-010-AW-W-04	5000-6500K	730								
TL-010-AW-W-05	5000-6500K	730	24°							
TL-010-AW-NW-05	4000-4500K	730								
TL-010-AW-WW-05	2700-3200K	670								
TL-010-AW-WW-06	2700-3200K	670	36°							
TL-010-AW-NW-06	4000-4500K	730								
TL-010-AW-W-06	5000-6500K	730								
TL-010-AW-W-07	5000-6500K	730	18°	4-wire track						
TL-010-AW-NW-07	4000-4500K	730								
TL-010-AW-WW-07	2700-3200K	670								
TL-010-AW-WW-08	2700-3200K	670	24°							
TL-010-AW-NW-08	4000-4500K	730								
TL-010-AW-W-08	5000-6500K	730								
TL-010-AW-W-09	5000-6500K	730	36°							
TL-010-AW-NW-09	4000-4500K	730								
TL-010-AW-WW-09	2700-3200K	670								



Package Information

Net weight:0.48kg/pcs

Gross weight:0.56kg/pcs,

One carton:7.3 kg(12pcs)

Package Dimension:212 * 128 * 86mm/pcs,530 * 240 * 275 mm/ctn

Dimensions (Unit: mm)

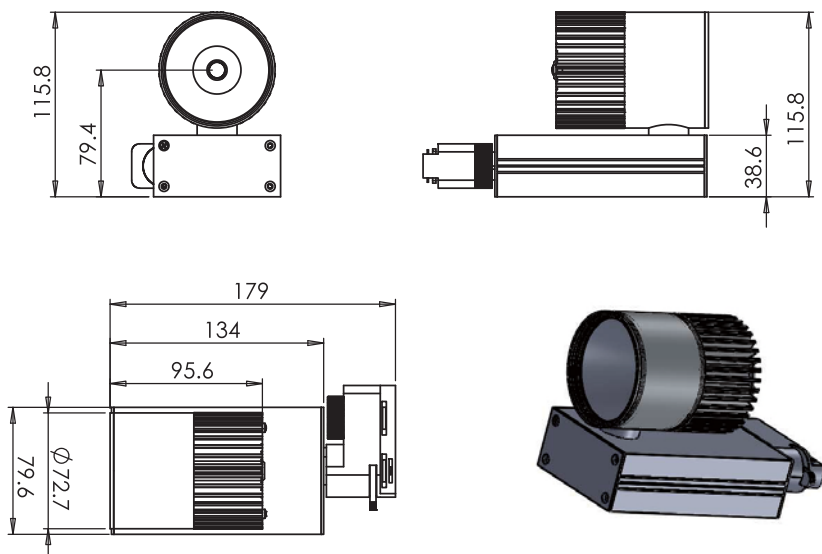

How to fix

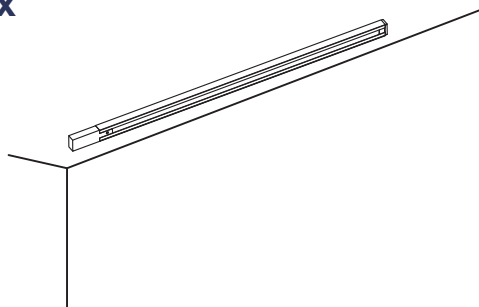

1. Fix the track on the ceiling;

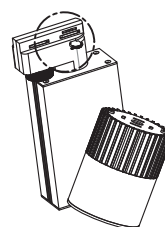

2. Flat joint, as installation figure;

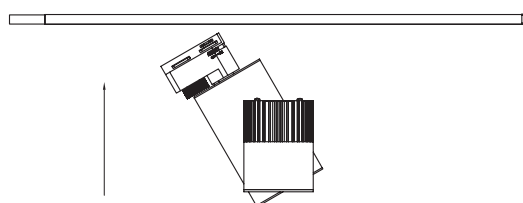

3. Push the LED track light into the track;

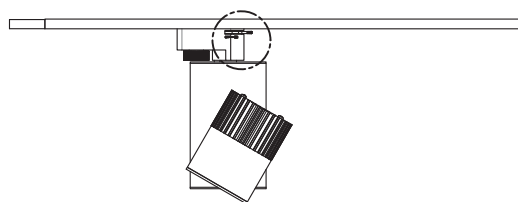

4. Fix the joint, as figure.



Installation Information (according to installation figures)

- 1.Power off before installation;
- 2.Avoid installing the light in places of heat source, super-heated vapor, corrosive gas to effect lifespan;
- 3.Make sure the installation material can endure 10 times the weight of light;
- 4.Install the light in places of no vibration, no swing, no fire hazard.

Notice

- 1.Please first read the product specification carefully, make sure the using environment conform to specification, then it can be used;
- 2.Please confirm the input voltage, frequency before use;
- 3.This product must be installed by professionals;
- 4.If there is any damage to the power wire or shell of the product, it should be taken as defective product and do not use it;
- 5.Dangerous high voltage, non-professionals are not allowed to maintain the product;
- 6.If external soft cable or soft wire of the light is damaged, it should be replaced by manufacture or service agent or personnel with similar qualification to avoid danger.