



## Ultra-slim Flood Light/10W FL-010-AW-S



### Description:

Flood light series light up the future of industry energy-saving lighting in world. This light save energy at least 50% compared to high intensity discharge lamp, and it also reduce maintenance cost and carbon emission.

The flood light is combined with LED cutting-edge technology and unique optical design to reach lighting effect equal to other traditional lighting source.

### Features:

1. Adopt waterproof design, no adhesive to cause leakage of aging, easy to disassemble;
2. Die-casting aluminum alloy lamp body, high toughened glass cover; solid and durable; corrosion-proof;
3. High efficiency thermal management, LEDs and power supply work in low temperature, and high stability of continuous operating.
4. Can on-off frequently, no flicker and glare; high CRI; Compact appearance, novel design, easy to install and transport.
5. Compact appearance, novel design, convenient to install and transport .



## Technical parameters:

Model	CCT	Color	LED Type	LED Qty.	Lumen(lm) (±10%)	Power(w) (±10%)	Voltage, Frequency	Beam (angle°)	CRI	PF
FL-010-AW-W-S	5500-6500K	White	COB	1pcs	703	10	AC100-240V 50/60Hz	120°	> 70	≥0.9
FL-010-AW-NW-S	4000-4500K	Neutral White		1pcs	697	10		120°	> 70	≥0.9
FL-010-AW-WW-S	2700-3200K	Warm White		1pcs	629	10		120°	> 70	≥0.9

## Application :

Mainly applied in outdoor flood lighting, building decoration, industry, sports center, outdoor stadium, port, parking lot, and road if there is street light distribution system.

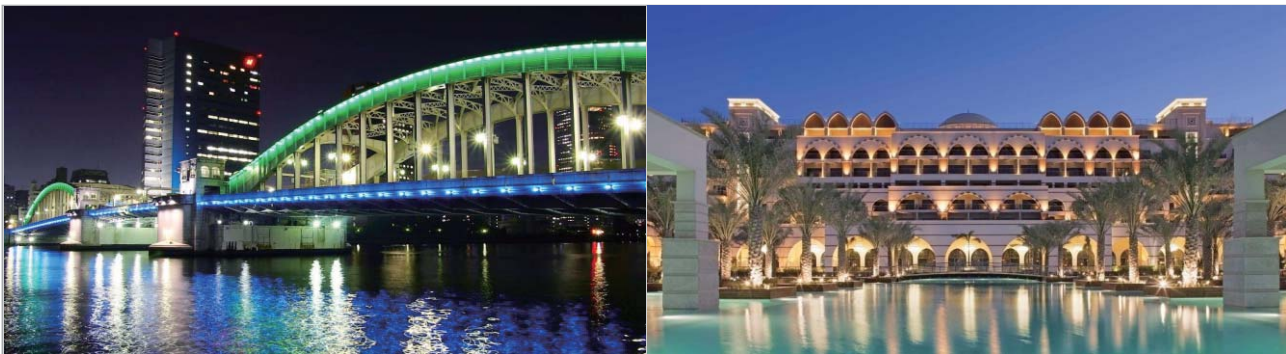

## Dimension (Unit:mm):

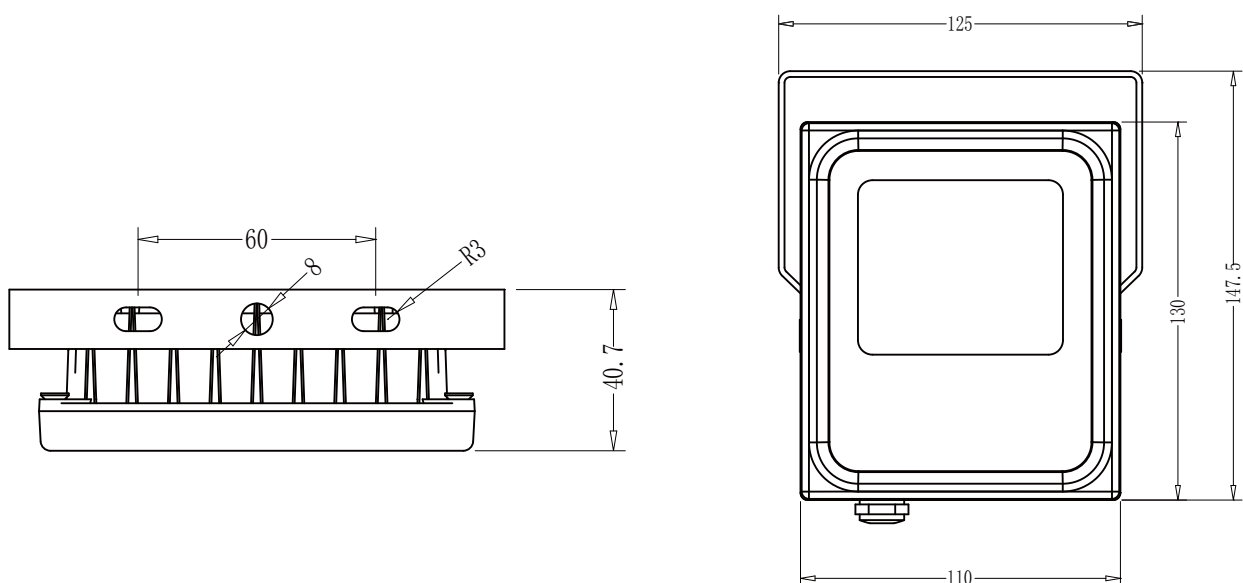



## Installation :



Step1: Drill two holes of 6.0mm diameter

1.Ceiling installation

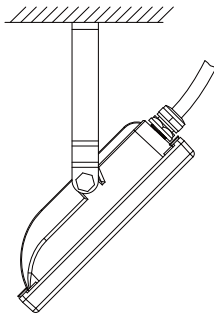

2. Wall mounted installation

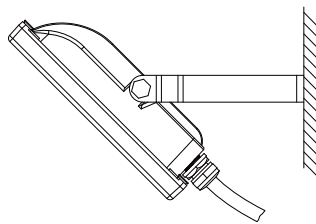

3. Pedestal installation

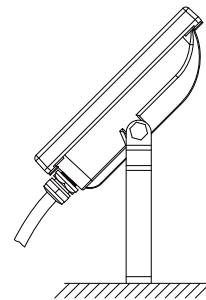

Step2: Install the bracket on the installing surface

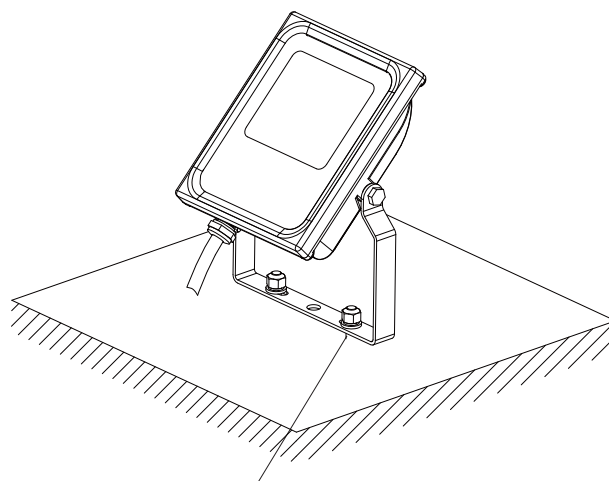

Step3: Fix the bracket and light together with bolts and nuts



## Packing information :

Net weight: 0.70 KG    Cross weight 0.75KG  
Packing box dimension: 137\*62\*195mm  
Outer carton dimension: 565\*405\*205mm (24 pcs/carton)  
Total weight:19.0KG

## Installation requirement:

- 1.Please prepare two sets of bolts to install the light;
- 2.Power off before installation;
- 3.Make sure the installed surface can endure the weight of light, and fix the light on the installed surface securely (according to installation diagram);
4. Connect light wire to power wire, seal the joint with insulation.

## Notice :

- 1.Please read the specification first, to make sure the service environment matches the conditions in the specification before using;
- 2.Please confirm input voltage, frequency before using;
3. The lamp must be installed by professionals;
4. The lamp can't be used if the power wire, housing are damaged;
5. The lamp can't be maintained by non-professionals;
- 6.If the exterior flexible cable or wire is damaged, it must be exchanged by the supplier, its agent or other relevant qualified personnel to avoid dangers;
- 7.Using environment: -20°C-40°C.