

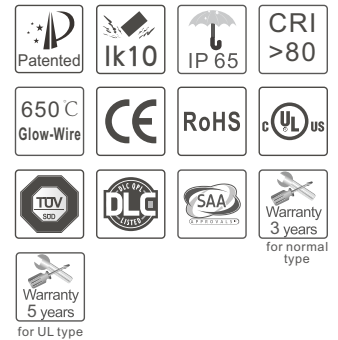

Tri-proof LED Lamp

TP-030-AW-W-H-03



Description

This product use durable long life span LED as light source, smooth light without glare, simple looking design. Impact-proof, water-proof and dust-proof, IP rating is up to IP65, can be used in different environment. Use aluminum alloy and PC as the material which ensure that it can work stably in different environment.

Features

1. ArcS I series tri-proof lamp with 230° beam angle to replace fluorescent tube;
2. Water-proof, dust-proof, impact-proof design, can be used in harsh environment;
3. Use fire-resistant PC cover, can pass 650° glow wire test;
4. High efficiency, up to 140 lm/w;
5. External power supply, easy to maintain;
6. Anti-glare cover, protect eyes better.



Specification

Model Number	Color	LED Type /Quantity	Light Output (lumen)	Beam Angle (degrees)	CCT	CRI	Max.Current (Amps)	Power (W)	Voltage	PF
TP-030-AW-W-H-03	White	SMD 2835 LED (216PCS)	4070	230	5500-6500K	>80	0.4	30	AC 100-277V 50/60Hz	≥0.9
TP-030-AW-NW-H-03	Natural white		3930	230	4000-4500K					
TP-030-AW-WW-H-03	Warm white		3800	230	2700-3200K					

Application

The lamp can be used for outdoor hallway, factory, basement, warehouse, parking lot...



Dimensions(Unit:mm/inch)

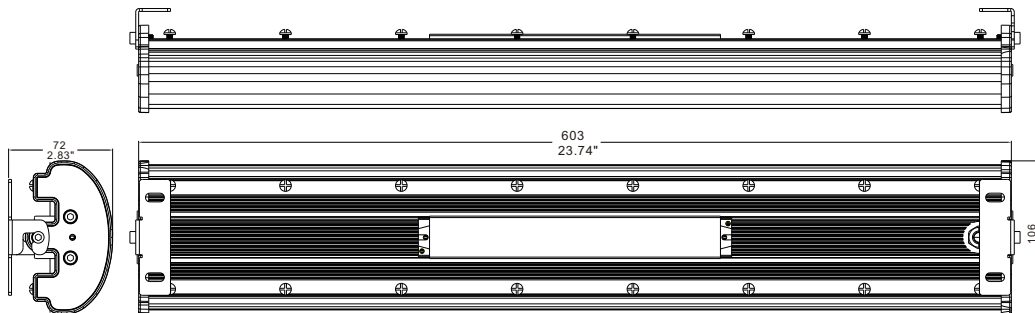

How to fix

Intallation Method I

Size:(mm)

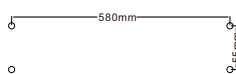

1. Drill 4 holes of 8mm diameter.

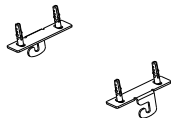

2. Install the holder on the wall, be attention that the direction should be the same.

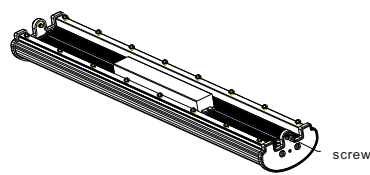

3. Turning the screw but not tightly, leave 3-4mm space.

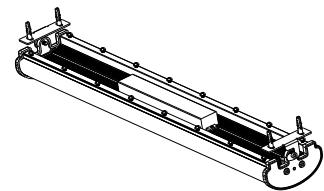

4. Install the light and tighten the screw.



Installation Method II

Size:(mm)

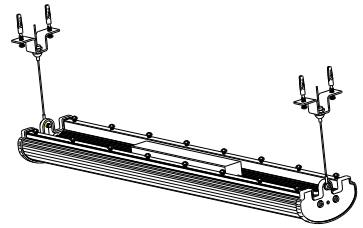
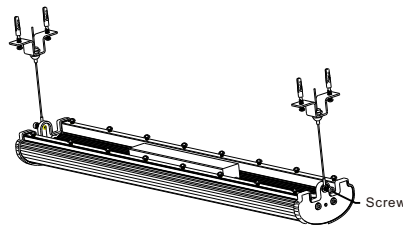
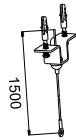
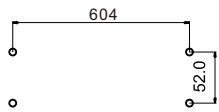

1. Drill 4 holes of 6.5mm.

2. Install the clip onto the wall.

3. Use screws to connect the hanging ring with screw holes on both sides of the lamp.

4. Adjust the height of the wires of both sides.

Installation information

1. First set up accessories and fittings of the light.
2. Cut off the power before installation.
3. Make sure the product is fixed tightly to the installation surface (install it according to diagram as below).
4. Connect the wire of the light to the power supply, then switch on the power.

Package information

Net Weight: 1.3kg

Gross Weight: 1.4 kg

White box size: 113*80*628 mm

Package size: 646*357*270mm (9PCS per box, gross weight:12.6kg)

Other Cautions

1. This product must be installed by professional personnels.
2. If there is any damage on the power line or the shell of the product, it should be taken as defective product and do not use it.
3. Dangerous high voltage, non-professionals are not allowed to maintain the product.